

**CODE NUMBER**

3375348

**DESCRIPTION**

0.5 gpf, Polished Chrome Finish, Single Flush, Electrical Override, Solar, Fits Zurn, SOLIS® Exposed Sensor Urinal Retrofit Flushometer.

**DETAILS**

- Flush Volume: 0.5 gpf (1.9 Lpf)
- Finish: Polished Chrome (CP)
- Power Type: Solar
- Battery Life: 6 years
- Valve: Diaphragm
- Valve Body Material: Semi-red Brass
- Fixture Type: Urinal
- Fixture Connection: Top spud
- Override: Electrical (OR)
- Special Features: Fits Zurn (Z)

**FEATURES**

Quiet, Exposed, SOLIS®, Solar Powered, Sensor Activated Urinal Flushometer Retrofit Conversion Kit for Royal®, Sloan® and Regal®

- User friendly three (3) second Flush Delay
- “Low Battery” Flashing LED
- Solar Powered. The sensor assembly is powered by a solar cell that will harvest power from the artificial indoor light (incandescent, fluorescent or LED), and use it as the energy source. The solar cell can provide approximately 100% power with 650 illuminance (lux).
- Four (4) Size AA Battery Back-up Power Source
- Infrared Sensor with Multiple-focused, Lobular Sensing Fields for high and low target detection
- Fixed Metering Bypass and No External Volume Adjustment to Ensure Water Conservation
- PERMEX® Synthetic Rubber Flex Tube Diaphragm with twin linear filtered bypass and vortex cleansing action
- Flex Tube Diaphragm designed for improved life and reduced maintenance
- Engineered Metal Cover with replaceable Lens Window
- ADA Compliant Sloan Solis® Solar Powered Infrared Sensor for automatic “No Hands” operation
- Diaphragm molded from PERMEX® Rubber Compound for Chloramine resistance
- Courtesy Flush® Override Button



**COMPLIANCES & CERTIFICATIONS**



(ADA Compliant, BREEAM Water Credit, Green Globes Water Credit, Satisfies LEED Credits)

**RECOMMENDED SPECIFICATION**

Valve Body, Cover, Tailpiece and Control Stop shall be in conformance with ASTM Alloy Classification for Semi- Red Brass. Valve shall be in compliance with the applicable sections of ASSE 1037 and ANSI/ASME 112.19.2.

**ELECTRICAL SPECIFICATIONS**

- Battery Life: 6 years

**VALVE OPERATING PRESSURE (FLOWING)**

15–80 PSI (103–552 kPa). Specific fixtures may require greater minimum flowing pressure - consult manufacturer requirements.

**DOWNLOADS**

- [Control Stop Repair and Maintenance Guide](#)
- [Flush Connections Flanges Repair and Maintenance Guide](#)
- [Tail Piece Repair and Maintenance Guide](#)
- [Exposed Solis Repair and Maintenance Guide](#)
- [Additional Downloads](#)

**NOTES**

All information contained within this document subject to change without notice.

Looking for other variations of the SOLIS RESS-U product? [View the general spec sheet with all options.](#)

[Find a compatible urinal](#) for this flushometer.

[Find a compatible water closet](#) for this flushometer.

**Sloan 10500 Seymour Ave, Franklin Park, IL 60131**

Phone: 800.982.5839 • Fax: 800.447.8329 • [sloan.com](http://sloan.com)

**ROUGH-IN**

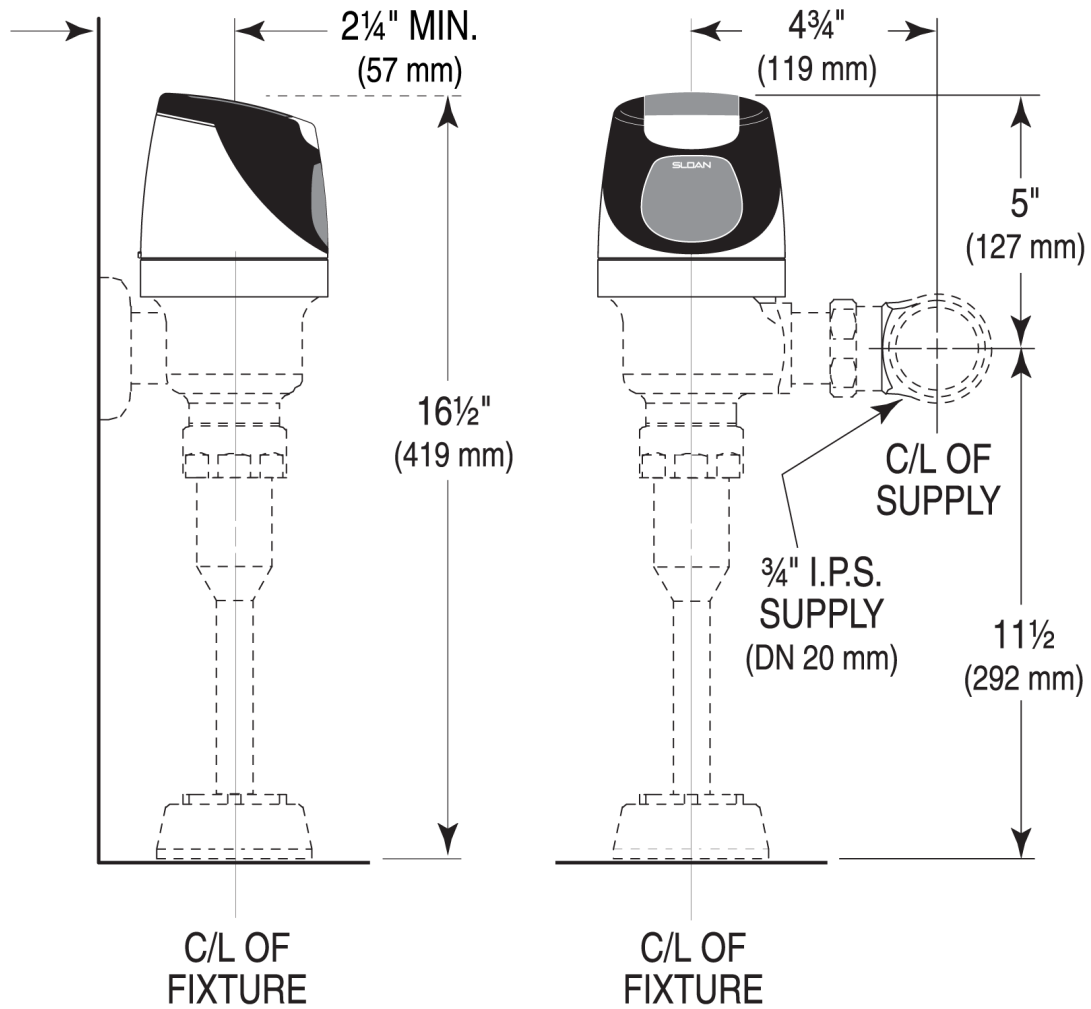

Sloan 10500 Seymour Ave, Franklin Park, IL 60131  
Phone: 800.982.5839 • Fax: 800.447.8329 • [sloan.com](http://sloan.com)