

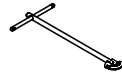

OLYMPIA FAUCETS, INC.
 3325 S. Garfield Ave.
 Commerce, CA 90040
 (888) 772-7701
 www.olympiafaucets.com

INSTALLATION

Tools:



Basin Wrench Adjustable Wrench Plumbers Putty Teflon Tape Rags

Model Number: L-6160H, L-6161H, L-6162H
 L-6260H, L-6262H



Warnings and Notes:

Check with local plumbing code requirements before installation.
 This product should be installed by a local listed plumber.
Do not use plumbers putty on threads.

Installation Steps:

Single Handle Lavatory Faucet

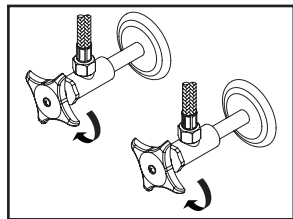

(1) Shut off the water supply. Remove old faucet. Clean mounting surface in preparation for new faucet.

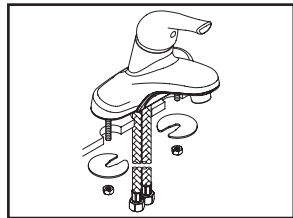

(2) Thread mounting bolts to the bottom of faucet. Carefully lead both stainless steel flex inlet lines through center mounting holes, align faucet on the mounting surface. Slide mounting plate to the mounting bolts from underneath of the sink and thread mounting nut onto mounting bolts. Tighten mounting nut with help of basin wrench or adjustable wrench.

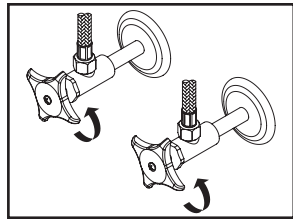

(3) Connect hot and cold inlet supply hoses to supply stops. For supply stop with 1/2" outlet connection, use 3/8" male to 1/2" female adapter for installation. Adapters are optional and are not provided with the faucet. Turn on both side supply stops to check any leaks.

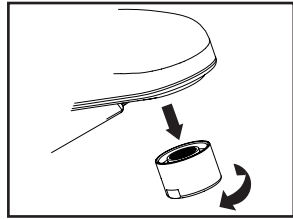

(4) Important: After installation is complete, remove the aerator. Turn on the water and allow both hot and cold water to run for at least one minute each. While water is running, check for leaks. Turn off the water and replace the aerator when finished.

Pop-Up Drain Installation:

"DO NOT USE THREAD SEALANTS, TEFLON TAPE ONLY"
"NO USE SELLADORES DE ROSCA, UTILIZAR SOLO CINTA DE TEFLON"

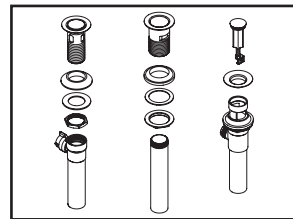

(1) a. For brass pop-up: Remove flange from drain body.
 b. For 50/50 type pop-up: Remove rubber gasket, flat washer, and lock nut from metal drain body.

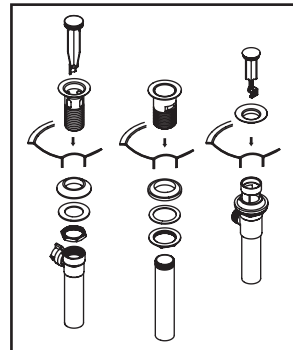

(2) a. For brass pop-up: Place a ring of plumbers putty on the bottom of the flange and apply Teflon tape on threaded tailpiece. Thread tailpiece to drain body. Insert flange through drain hole and attach drain body to flange from underneath the sink.
 b. For 50/50 type pop-up: Place a ring of plumbers putty on the bottom of the flange. Insert drain body through drain hole. Thread rubber gasket, flat washer, and lock nut onto drain body. Apply Teflon tape only on the threaded area and attach tailpiece to drain body. **Please Note: Use Teflon tape only on all thread connection areas. Using pipe thread sealant might weaken material structure and cause leaks.**

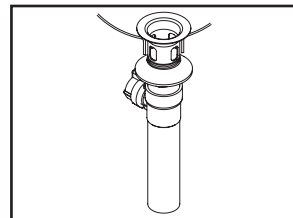

(3) Ensure the pivot rod hole on the pop-up body faces toward the back of the sink. Tighten the lock nut securely with a wrench.

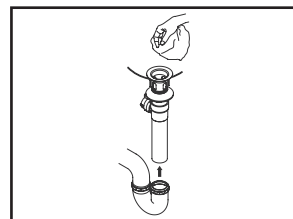

(4) Connect pop-up tail piece to the trap (check manufacturer's instruction for installation) and remove the excess plumbers putty.

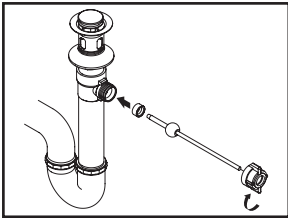

(5) Remove pivot rod nut from pop-up body and ensure the washer is in place. Insert pivot rod and tighten rod nut back to pop-up body.

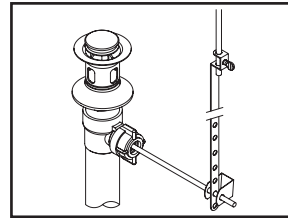

(7) Connect lift rod strap to pivot rod by using clip. Tighten thumbscrew to connect lift rod strap to pop-up lift rod.

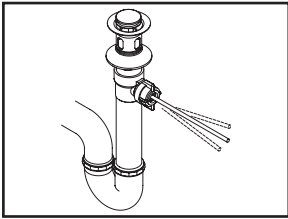

(6) Push pivot rod down and insert drain plug carefully. Test to ensure drain plug works properly.

Exploded Drawing (L-616XH):

* Note: Please specify finish/color when ordering.

| | ITEM # | DESCRIPTION |
|---|------------|---|
| A | OP-190001* | Metal Lever Handle |
| B | OP-490003* | Cap & Adjusting Ring |
| C | OP-490004 | Cam & Washer |
| D | OP-390001 | Stainless Steel Ball |
| E | OP-490041 | Springs and Seats |
| F | OP-490064* | 1.2 GPM Aerator |
| G | OP-530001 | Mounting Kit |
| H | OP-630004* | 50/50 Pop-Up Drain Assembly (For L-6160H) |
| I | OP-630002* | Brass Pop-Up Drain Assembly (For L-6162H) |
| 1 | OP-490002 | Hot & Cold Indicator |
| 2 | OP-490043 | Allen Screw |

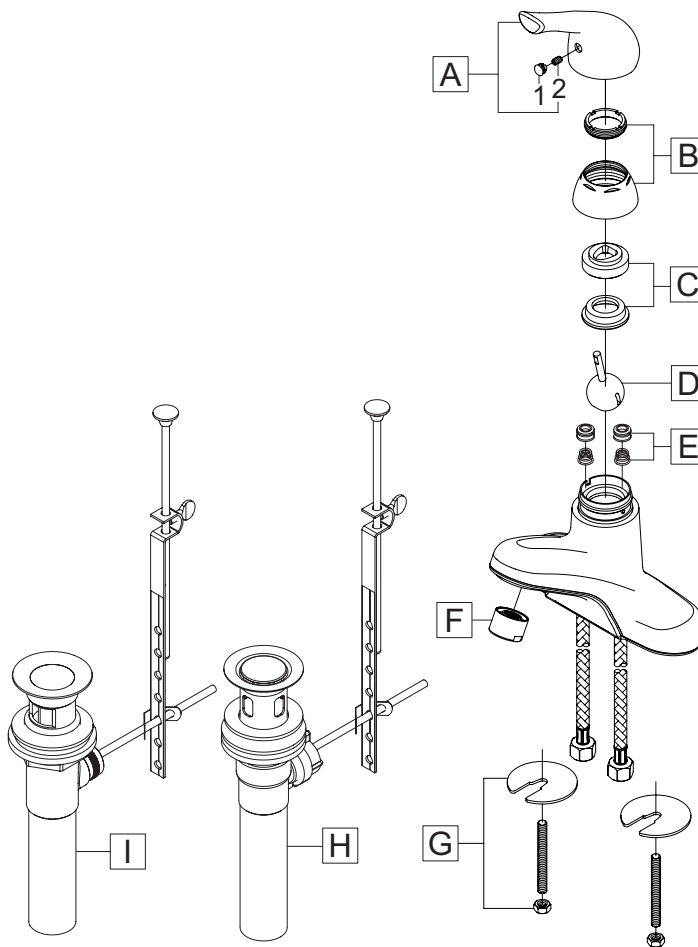

Exploded Drawing (L-626XH):

* Note: Please specify finish/color when ordering.

| | ITEM # | DESCRIPTION |
|---|------------|--|
| A | OP-190001* | Metal Lever Handle |
| B | OP-490003* | Cap & Adjusting Ring |
| C | OP-490004 | Cam & Washer |
| D | OP-390001 | Stainless Steel Ball |
| E | OP-490041 | Springs and Seats |
| F | OP-490065* | 1.2 GPM Aerator |
| G | X-4300003 | Base Gasket |
| H | OP-530001 | Mounting Kit |
| I | OP-630004* | 50/50 Pop-Up Drain Assembly (For L-6260H) |
| J | OP-630002* | Brass Pop-Up Drain Assembly (For L-6262H) |
| 1 | OP-490002 | Hot & Cold Indicator |
| 2 | OP-490043 | Allen Screw |

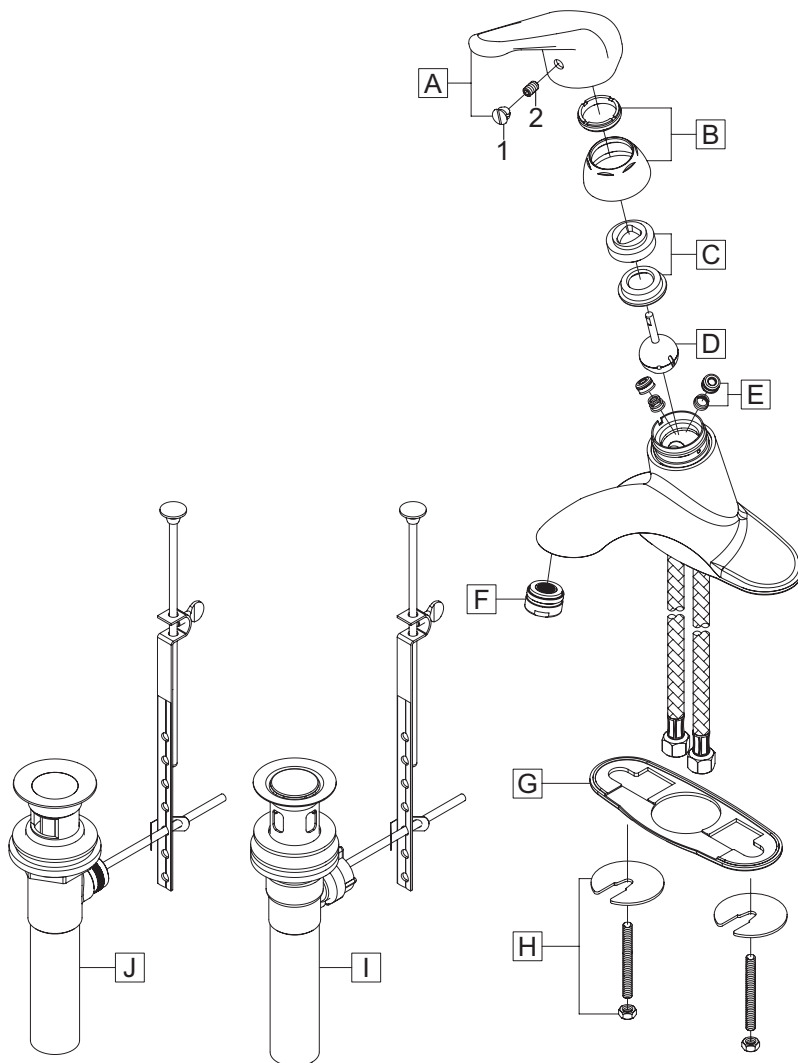

For more care information or trouble shooting inquiries about your Olympia product, Please call:
OLYMPIA FAUCETS, INC. (888) 772-7701
 Monday-Friday 8 AM to 8 PM EST (5 AM to 5 PM PST)
www.olympiafaucets.com